

30 TOOTH "L" SECTION 3/8" PITCH PULLEY SUITABLE FOR MAGNA CORDIS PUMPS

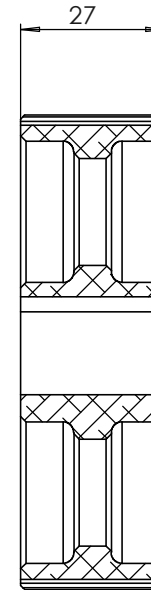

SECTION B-B

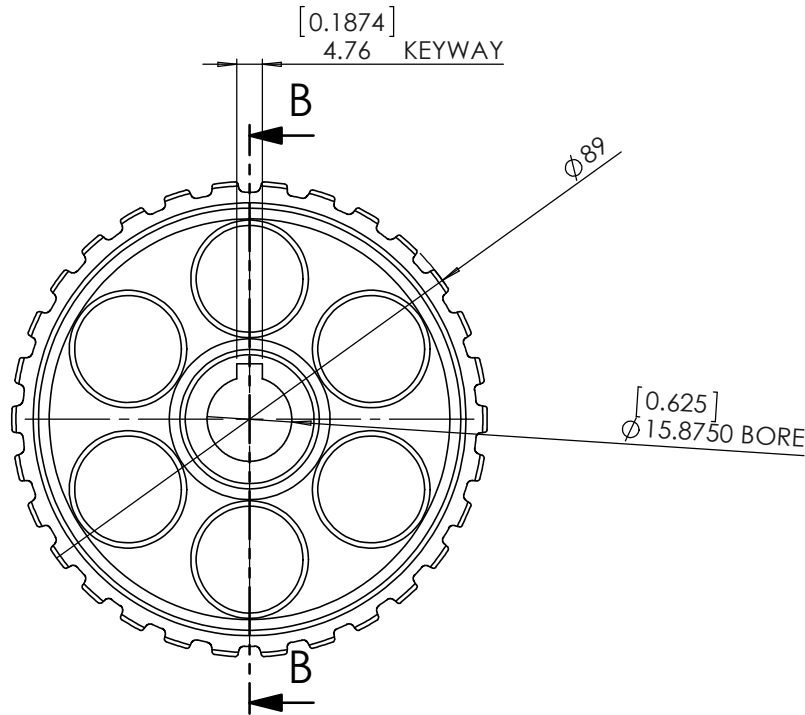

COPYRIGHT (c) 2013
AT POWER LTD
UNIT 9, CHESTNUT DRIVE, WYMONDHAM,
NORFOLK, UK, NR18 9SB

UNLESS OTHERWISE STATED:
DIMENSIONS IN MILLIMETRES
TOLERANCES: LINEAR ± 0.1 ANGULAR ± 0.5°
SURFACE FINISH √ = √
DRAWING STANDARDS TO ATQS 6003
DATE FORMAT: DD/MM/YY

THIS DESIGN IS THE PROPERTY OF
AT POWER THROTTLES LTD AND
MUST NOT BE REPRODUCED OR
COMMUNICATED WITHOUT
AUTHORITY

CAD PLOT
DO NOT
SCALE

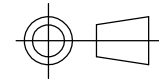

THIRD ANGLE PROJECTION
SCALE 1:1 WEIGHT 0.15 kg

DRAWN - M.DAVIS
DATE - 07/01/15

CHECKED - S.HOW
APPROVED - A.CLIFTON

MATERIAL
ALUMINIUM HE30

FINISH
HARD ANODISED

DRAWING TITLE
PULLEY - PUMP - 30 TOOTH -
1" WIDE - 5/8" BORE

DRAWING NUMBER
104-204-00024